



HOSHIZAKI

SUSHI CABINETS

HNC-150BE-R-B

Counter Showcase



Product Features

- Attractive top glass angles down
- Plate space on top of unit - 5.6 inches
- Stable humidity and temperature levels are maintained instead of forced air circulation methods that dry out and ruin displayed sushi
- Large diameter 1 inch drains at front
- Larger front to back interior - 11 inches
- Interior floor has a radius at all four sides
- Self-contained refrigeration unit - easy to install
- Left and right side compression location options available
- Condenser airflow is in the back and out the side
- Large diameter upper evaporator with tin plating
- Larger condenser face area improves cooling performance
- Solid base food plates with radius groove to fit sushi foods
- Base food plates can be turned upside down and used to improve cooling performance
- R-134a Refrigerant
- Exterior consists of clear glass, ABS Plastic, PVC Plastic and Stainless Steel
- Interior consists of clear glass, ABS Plastic and Stainless Steel





Product Specifications

- **Exterior Dimensions**
Width: 1500mm
Depth: 345mm
Height: 270mm
- **Interior Dimensions**
Width: 1145mm
Depth: 288mm (floor)
Height: 157mm
- **Weight**
Net: 37kg
Packed: 52kg
- **AC Supply Voltage**
220-240V/50Hz, 10AMPs
- **Rated Amperage**
1.1A
- **Saturation Temperature**
Approx 4°C (Ambient temp 30°C, no load)
- **Net Capacity** 57L
- **Ambient Temperature**
10°C – 30°C
- **Refrigeration System**
Convection Cooling

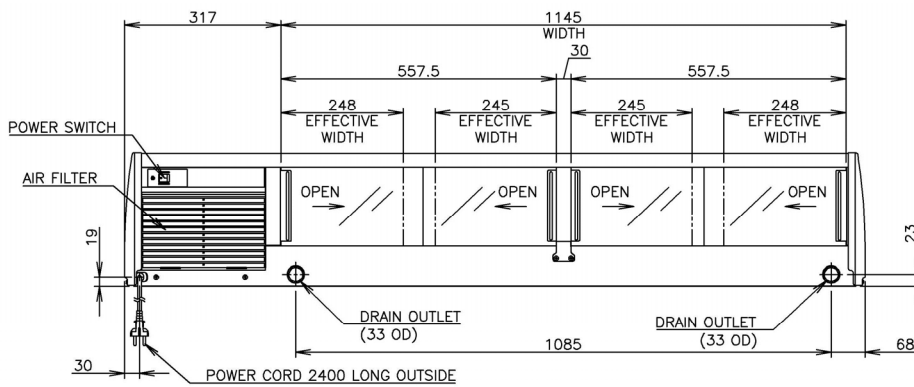

VIEW A (REAR)

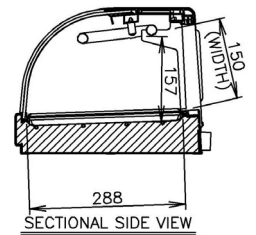
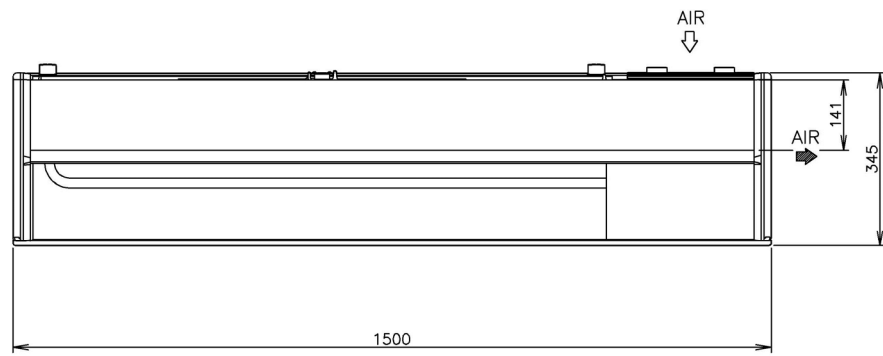
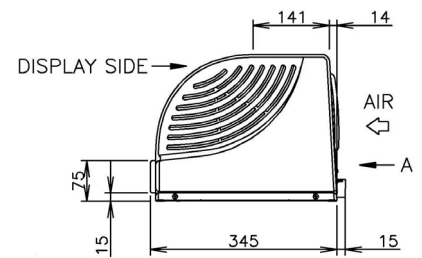

SECTIONAL SIDE VIEW

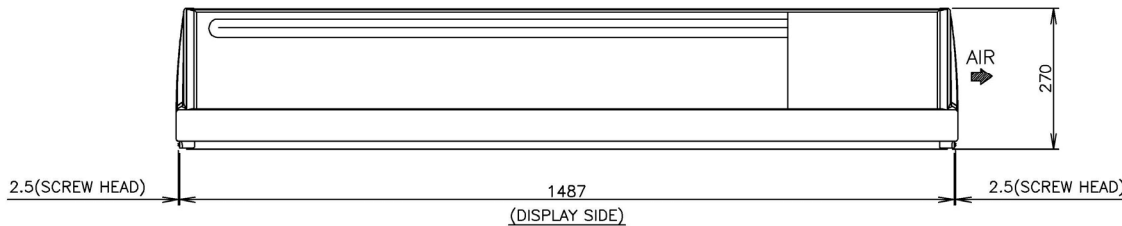

(DISPLAY SIDE)

